

72001	ÖBB	Rh 2062	=	🔊	
78001			=	🔊	~

Pos. Nr. Pos.no.	Beschreibung Description	Art.-Nr. Art.no.	Preisgruppe Price bracket
1	Gehäuse kpl. Betr. nr. 2062.35 Body ass. complete Loco. no. 2062.35	145098	34
2	Platine mit Decoder PCB with decoder	145074	42
3	Flexleiter Flexible light conductor	145075	11
4	Spule Spool	143766	13
5	Lautsprecher Loudspeaker	129524	14
6	TS - Scheinwerfer+Lampenringe Part set - Headlight+lamp rings	145084	11
7	Kessel + Kästen Boiler + boxes	145085	8
8	Rahmenbleche Frame plates	145086	6
9	TS - Fenster + Lichtnägel Part set - Windows + light pins	145087	11
10	TS - Auftritte Part set - Steps	145089	7
11	TS - Wischer, Ablassrohr Part set - Wipers, drain pipe	145090	7
12	TS - Griffe Part set - Handles	145091	8
13	Dose Socket	145093	3
14	Griff Umlauf Handle for running board	145094	4
15	Auspuff+Kühlergrill Chimney+grill	145099	12
16	Auspuffrohr Chimney pipe	145100	8
17	Lokpfeife Messing Whistle	88002	6
18	Türgriff Handrail	145102	6
19	GF-Schraube M1 6x4 mm GF-Screw	114850	3

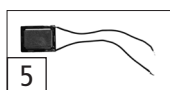

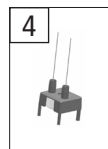
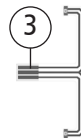
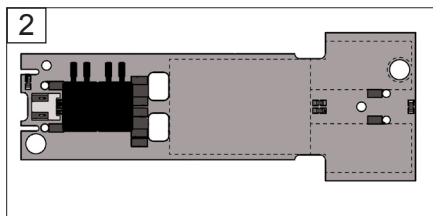
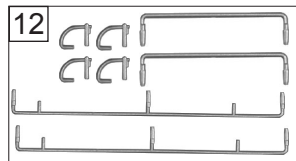
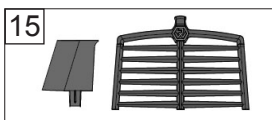
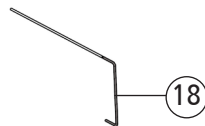
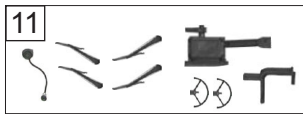
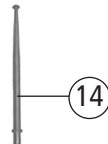
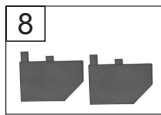
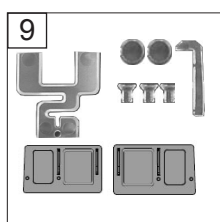
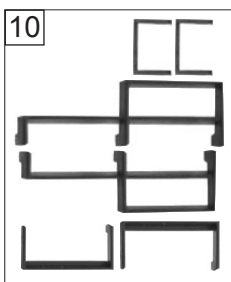
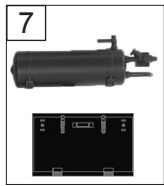
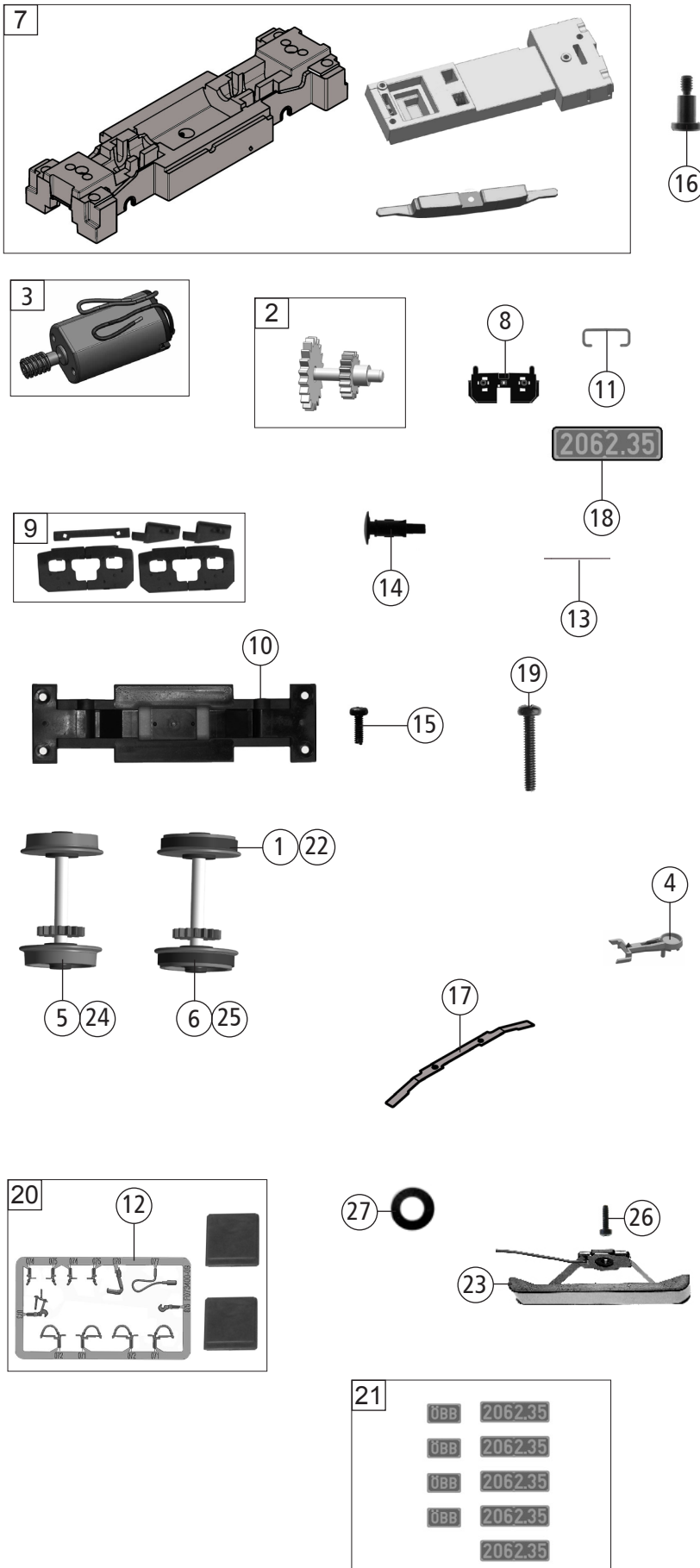

72001		ÖBB	Rh 2062	=	🔊	
78001				=	🔊	~
Pos. Nr. Pos.no.	Beschreibung Description	Art.-Nr. Art.no.	Preisgruppe Price bracket			
1	Hafrings 10 stk. 10,3-12,8 Traction tyre	40069	---			
2	Getriebe kpl. Gearbox complete	145076	9			
3	Motor Motor	145077	18			
4	Digi-Kupplung Digital coupling	145078	11			
5	Radsatz m.Zahnr. o.Haftr. Wheelset w. gearwh. w/o traction tyre	145079	11			
6	Radsatz m.Zahnr. m. 2 Haftr. Wheelset w. gearwh. w. 2 traction tyres	145080	12			
7	TS - Grundrahmen Part set - Base frame	145081	17			
8	Rahmen l+b Frames	145082	13			
9	TS - Ballast, Kontakthalter Part set - Weight,contact holder	145083	10			
10	Boden Bottom	145088	4			
11	Puffergriff Buffer handle	145092	4			
12	TS - Bremschläuche + Zughaken Part set of brake tubes & coupling hooks	139832	7			
13	Federdraht L=18 D=0,25 mm Spring wire	145095	4			
14	Puffer Buffer	145096	5			
15	GF-Schraube M 2x12 mm GF-Screw	114944	3			
16	Ansatzschraube M2x4 mm Flanged screw	108167	4			
17	Radkontakt L=55,6 mm Contact	145097	8			
18	Nummerntafel Number plates	145101	8			
19	Schraube M 2x20 mm Screw	108926	3			
20	Zurüstbeutel Bag of accessories	145103	9			
21	Tafelsatz Set of panels	145104	12			
AC - Wechselstrom						
22	Hafrings 10 stk. 10,3-12,4 Traction tyre	40074	---			
23	Schleifer kurz Slider short	40064	---			
24	Radsatz m.Zahnr. o.Haftr. AC Wheelset w. gearwh. w/o traction tyre	145105	11			
25	Radsatz m.Zahnr. m. 2 Haftr. AC Wheelset w. gearwh. w. 2 traction tyres	145106	12			
26	PT-Schraube M1 5x5 mm PT-Screw	108137	3			
27	Beilagescheibe Washer	86108	3			